

[www.homelux.co.uk](http://www.homelux.co.uk)



**HOMELUX<sup>®</sup>**  
THE PERFECT FINISH  
TO YOUR TILING PROJECT  
  
2022













# ABOUT & CONTENTS

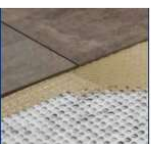

**HOMELUX<sup>®</sup>**

**HOMELUX<sup>®</sup> OFFER A WIDE RANGE OF SOLUTIONS TO COMPLETE ANY TILING PROJECT FOR THE PROFESSIONAL AND DIY USER**



TILE TRIMS	4-23	
LISTELLO BORDERS	24-25	
BATH & SHOWER SEALS	26-27	
WATERPROOF MATTING	28-29	
ANTI-CRACK MATTING	30-31	
UNDERTILE HEATING	32-33	
KITCHEN TRIMS & SEALS	34-35	
FLOORING	36-37	
BUILDING PRODUCTS, ANGLES & EDGES	38-39	
MARKETING SOLUTIONS	40-42	



TILE  
TRIMS

**HOMELUX<sup>®</sup>**

**TILE  
TRIMS**

HOMELUX<sup>®</sup> TILE TRIMS  
PROVIDE THE FINISHING TOUCH

# YOUR GUIDE TO TILE TRIMS

## WHAT DOES TILE TRIM DO?

- ✓ Caps and protects tile edges from getting chipped or damaged
- ✓ Hides the raw edges of a tile that is glazed or looks unfinished where cut
- ✓ Hides the raw edges of unglazed tiles
- ✓ Covers sharp edges of tiles

## HOW DO I KNOW WHAT SIZE TILE TRIM TO USE?

First measure the thickness of the tile and add 1-2mm to this to allow for a covering of adhesive.

## WHERE WOULD I USE ONE?

Tile Trims are versatile and can be used in many applications...



Part-tiled walls



Splashbacks



To separate between floor coverings



To frame around a window



External corners i.e. boxing in pipe work

PVC  
TILE TRIMS

**HOMELUX<sup>®</sup>**

# PVC TILE TRIMS

PVC TILE TRIMS PROVIDE A PRACTICAL,  
SMOOTH AND NEAT EDGE TO YOUR TILES  
IN VARIOUS PROFILES AND FINISHES



Proudly made in Great Britain, minimising environmental impact  
Contains no lead • Tough and long-lasting • Colour fast • 100% recyclable • Cost effective

WHITE

SOFT CREAM

BLACK

IVORY

WHITE

SOFT CREAM

## PVC ROUND EDGE TILE TRIM HOMELUX®

PRODUCT CODE	DESCRIPTION	COLOUR	LENGTH
<b>6mm</b>			
HTTS WH 6	Round Edge PVC Tile Trim	White	1.83m
10012217	Round Edge PVC Tile Trim	Soft Cream	1.83m
HTTS BK 6	Round Edge PVC Tile Trim	Black	1.83m
HTTS WH 25	Round Edge PVC Tile Trim	White	2.5m
HTTS SCR 25	Round Edge PVC Tile Trim	Soft Cream	2.5m
<b>9mm</b>			
HTTD WH 6	Round Edge PVC Tile Trim	White	1.83m
10012223	Round Edge PVC Tile Trim	Soft Cream	1.83m
HTTD BK 6	Round Edge PVC Tile Trim	Black	1.83m
HTTD WH 25	Round Edge PVC Tile Trim	White	2.5m
HTTD SCR 25	Round Edge PVC Tile Trim	Soft Cream	2.5m
<b>12.5mm</b>			
HTT125 WH 25	Round Edge PVC Tile Trim	White	2.5m
HTT125 SCR 25	Round Edge PVC Tile Trim	Soft Cream	2.5m



## PVC ROUND EDGE TILE TRIM TRADE

PRODUCT CODE	DESCRIPTION	COLOUR	LENGTH
<b>6mm</b>			
HTRT6 WH	Round Edge PVC Tile Trim - Trade	White	2.44m
HTRT6 SCR	Round Edge PVC Tile Trim - Trade	Soft Cream	2.44m
<b>9mm</b>			
HTRT9 WH	Round Edge PVC Tile Trim - Trade	White	2.44m
HTRT9 SCR	Round Edge PVC Tile Trim - Trade	Soft Cream	2.44m
<b>12.5mm</b>			
HTRT125 WH	Round Edge PVC Tile Trim - Trade	White	2.44m

### PROFILES

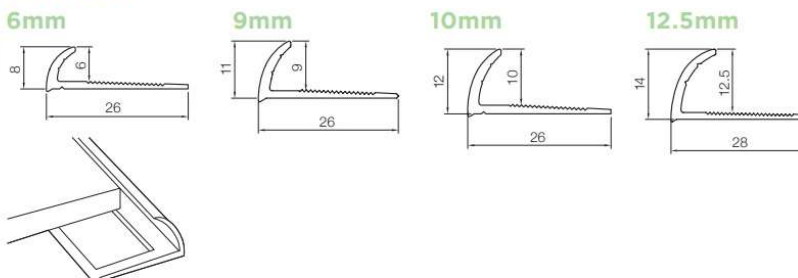



WHITE



SOFT CREAM



GREY



# PVC STRAIGHT EDGE TILE TRIM HOMELUX®

PRODUCT CODE	DESCRIPTION	COLOUR	LENGTH
<b>6mm</b>			
HPJT100	Straight Edge PVC Tile Trim	White	2.5m
HPJT106	Straight Edge PVC Tile Trim	Soft Cream	2.5m
<b>8mm</b>			
HPJT200	Straight Edge PVC Tile Trim	White	2.5m
HPJT206	Straight Edge PVC Tile Trim	Soft Cream	2.5m
HPJT8GR25	Straight Edge PVC Tile Trim	Grey	2.5m
<b>10mm</b>			
HPJT300	Straight Edge PVC Tile Trim	White	2.5m
HPJT306	Straight Edge PVC Tile Trim	Soft Cream	2.5m
HPJT10GR25	Straight Edge PVC Tile Trim	Grey	2.5m
<b>12.5mm</b>			
HPJT400	Straight Edge PVC Tile Trim	White	2.5m
HPJT125GR25	Straight Edge PVC Tile Trim	Grey	2.5m

## PROFILES

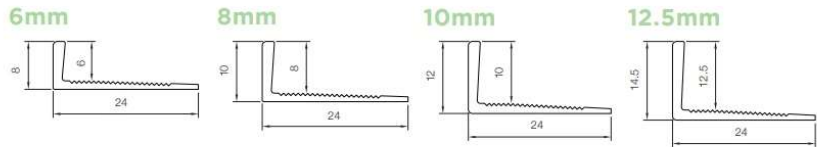



PVC  
TILE TRIMS

**HOMELUX<sup>®</sup>**

# SUPERGLOSS TILE TRIMS

HOMELUX<sup>®</sup> SUPERGLOSS QUADRANT TRIM  
PROVIDES A SUPER GLOSSY FINISH TO YOUR  
TILE EDGES. IT PROVIDES A PERFECT 3-WAY  
CORNER WHEN USED WITH A CORNER PIECE

**Supergloss**  
QUADRANT TILE TRIM



Complements high gloss ceramic tiles perfectly • Matching corner pieces  
Quick and easy to install - no mitering required • Extra long leg makes fitting easier  
Proudly made in Great Britain, minimising environmental impact • Contains no lead

## PVC SUPERGLOSS QUADRANT TILE TRIM TRADE

WHITE GLOSS



SOFT CREAM GLOSS



PRODUCT CODE	DESCRIPTION	COLOUR	LENGTH
<b>6mm</b>			
HQD6 WHGL 6	Supergloss Quadrant Tile Trim	White Gloss	1.83m
HQD6 WHGL	Supergloss Quadrant Tile Trim	White Gloss	2.44m
HQD6 SCRGL	Supergloss Quadrant Tile Trim	Soft Cream Gloss	2.44m
<b>8mm</b>			
HQD8 WHGL 6	Supergloss Quadrant Tile Trim	White Gloss	1.83m
HQD8 WHGL	Supergloss Quadrant Tile Trim	White Gloss	2.44m
<b>10mm</b>			
HQD10 WHGL 6	Supergloss Quadrant Tile Trim	White Gloss	1.83m
HQD10 WHGL	Supergloss Quadrant Tile Trim	Soft Cream Gloss	2.44m
HQD10 SCRGL	Supergloss Quadrant Tile Trim	White Gloss	2.44m

### PROFILES

6mm

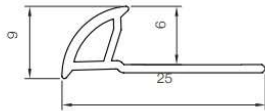

8mm

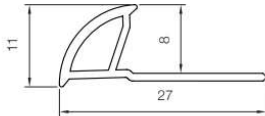

10mm

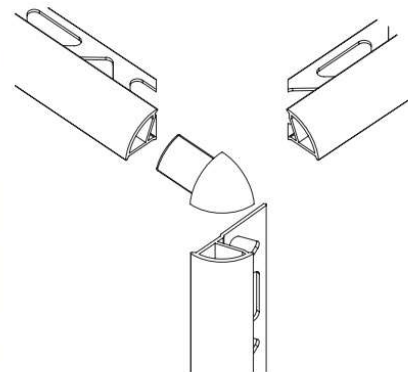
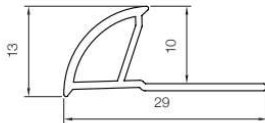

WHITE GLOSS



SOFT CREAM GLOSS



## PVC SUPERGLOSS QUADRANT CORNERS

PRODUCT CODE	DESCRIPTION	COLOUR
<b>6mm</b>		
HQDPC6 WHGL	Supergloss Quadrant Corners x100	White Gloss
HQDPC6 WHGL PK2	Supergloss Quadrant Corners x2	Soft Cream Gloss
<b>8mm</b>		
HQDPC8 WHGL	Supergloss Quadrant Corners x100	White Gloss
HQDPC8 WHGL PK2	Supergloss Quadrant Corners x2	Soft Cream Gloss
<b>10mm</b>		
HQDPC10 WHGL	Supergloss Quadrant Corners x100	White Gloss
HQDPC10 WHGL PK2	Supergloss Quadrant Corners x2	Soft Cream Gloss

METAL  
TILE TRIMS

**HOMELUX<sup>®</sup>**

# METAL TILE TRIMS

METAL TILE TRIMS CO-ORDINATE  
WITH THE LATEST STONE AND  
PORCELAIN TILES TO GIVE A  
CONTEMPORARY, STYLISH FINISH

Co-ordinate with other furniture - taps, lights and handles • Can be matched with metal borders  
Natural, muted tones • Match the latest trends in tiles • Complement natural coloured grout

## METAL ROUND EDGE TILE TRIM HOMELUX®



PRODUCT CODE	DESCRIPTION	COLOUR	LENGTH
<b>6mm</b>			
HATS SI 6	Round Edge Metal Tile Trim	Silver	1.83m
HATS SSE 6	Round Edge Metal Tile Trim	Stainless Steel	1.83m
HATS SI 25	Round Edge Metal Tile Trim	Silver	2.5m
HATS SSE 25	Round Edge Metal Tile Trim	Stainless Steel	2.5m
<b>9mm</b>			
HATD SI 6	Round Edge Metal Tile Trim	Silver	1.83m
HATD SSE 6	Round Edge Metal Tile Trim	Stainless Steel	1.83m
HATD SI 25	Round Edge Metal Tile Trim	Silver	2.5m
HATD SSE 25	Round Edge Metal Tile Trim	Stainless Steel	2.5m
<b>12.5mm</b>			
10012219	Round Edge Metal Tile Trim	Silver	1.83m
10010942	Round Edge Metal Tile Trim	Silver	2.5m
HAT125 SSE 25	Round Edge Metal Tile Trim	Stainless Steel	2.5m
HAT125 SSE 6	Round Edge Metal Tile Trim	Stainless Steel	1.83m

## METAL ROUND EDGE TILE TRIM TRADE



PRODUCT CODE	DESCRIPTION	COLOUR	LENGTH
<b>6mm</b>			
HATRT6 SI	Round Edge Metal Tile Trim - Trade	Silver	2.44m
<b>9mm</b>			
HATRT9 SI	Round Edge Metal Tile Trim - Trade	Silver	2.44m
<b>12.5mm</b>			
HATRT125 SI	Round Edge Metal Tile Trim - Trade	Silver	2.44m

### PROFILES

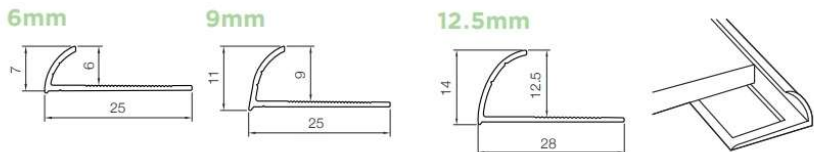

## METAL ROUND EDGE CORNERS

PRODUCT CODE	DESCRIPTION	COLOUR
<b>6mm</b>		
HACS2 SI	Round Edge Metal Tile Trim Corners	Silver
<b>9mm</b>		
HACD2 SI	Round Edge Metal Tile Trim Corners	Silver

# METAL STRAIGHT EDGE TILE TRIM HOMELUX®

SILVER



STAINLESS STEEL



GUN METAL GREY



BRUSHED BLACK



CARBON



INDUSTRIAL HAMMERED



PRODUCT CODE	DESCRIPTION	COLOUR	LENGTH
<b>6mm</b>			
HPJT6 SI 25	Metal Straight Edge Tile Trim	Silver	2.5m
HPJT6 SSE 25	Metal Straight Edge Tile Trim	Stainless Silver	2.5m
<b>8mm</b>			
HPJT8 SI 6	Metal Straight Edge Tile Trim	Silver	1.83m
HPJT8 SSE 6	Metal Straight Edge Tile Trim	Stainless Steel	1.83m
HPJT8 GMG 6	Metal Straight Edge Tile Trim	Gun Metal Grey	1.83m
HPJT8 CHAM 6	Metal Straight Edge Tile Trim	Champagne	1.83m
HPJT8 COP 6	Metal Straight Edge Tile Trim	Copper	1.83m
HPJT8 BB 6	Metal Straight Edge Tile Trim	Brushed Black	1.83m
HPJT8 SI 25	Metal Straight Edge Tile Trim	Silver	2.5m
HPJT8 SSE 25	Metal Straight Edge Tile Trim	Stainless Steel	2.5m
HPJT8 GMG 25	Metal Straight Edge Tile Trim	Gun Metal Grey	2.5m
HPJT8 WHGL 25	Metal Straight Edge Tile Trim	White Gloss	2.5m
HPJT8 BK 25	Metal Straight Edge Tile Trim	Black Gloss	2.5m
HPJT8CARB25	Metal Straight Edge Tile Trim	Carbon	2.5m
HPJT8LBGO25	Metal Straight Edge Tile Trim	Light Brushed Gold	2.5m



## METAL STRAIGHT EDGE TILE TRIM HOMELUX®

**MARBLE**



**PEWTER**



**LIGHT BRUSHED GOLD**



PRODUCT CODE	DESCRIPTION	COLOUR	LENGTH
<b>10mm</b>			
HPJT10 SI 6	Metal Straight Edge Tile Trim	Silver	1.83m
HPJT10 SSE 6	Metal Straight Edge Tile Trim	Stainless Steel	1.83m
HPJT10 GMG 6	Metal Straight Edge Tile Trim	Gun Metal Grey	1.83m
HPJT10 CHAM 6	Metal Straight Edge Tile Trim	Champagne	1.83m
HPJT10 COP 6	Metal Straight Edge Tile Trim	Copper	1.83m
HPJT10 BB 6	Metal Straight Edge Tile Trim	Brushed Black	1.83m
HPJT10 SI 25	Metal Straight Edge Tile Trim	Silver	2.5m
HPJT10 SSE 25	Metal Straight Edge Tile Trim	Stainless Steel	2.5m
HPJT10 BK 25	Metal Straight Edge Tile Trim	Black Gloss	2.5m
HPJT10 WHGL 25	Metal Straight Edge Tile Trim	White Gloss	2.5m
HPJT10INDH25	Metal Straight Edge Tile Trim	Ind. Hammered	2.5m
HPJT10CARB25	Metal Straight Edge Tile Trim	Carbon	2.5m
HPJT10GMG25	Metal Straight Edge Tile Trim	Gun Metal Grey	2.5m
HPJT10CHAM25	Metal Straight Edge Tile Trim	Champagne	2.5m
HPJT10COP25	Metal Straight Edge Tile Trim	Copper	2.5m
HPJT10BB25	Metal Straight Edge Tile Trim	Brushed Black	2.5m
HPJT10LBGO25	Metal Straight Edge Tile Trim	Light Brushed Gold	2.5m
HPJT10MAR25	Metal Straight Edge Tile Trim	White Marble	2.5m
HPJT10PEW25	Metal Straight Edge Tile Trim	Pewter	2.5m
HPJT10GGTR25	Metal Straight Edge Tile Trim	Grey Glitter	2.5m
HPJT10SGTR25	Metal Straight Edge Tile Trim	Silver Glitter	2.5m
HPJT10BGTR25	Metal Straight Edge Tile Trim	Black Glitter	2.5m
HPJT10GDGTR25	Metal Straight Edge Tile Trim	Gold Glitter	2.5m



**GOLD  
GLITTER**



**SILVER  
GLITTER**



**GREY  
GLITTER**



**BLACK  
GLITTER**



**NEW  
FOR  
2022**



# METAL STRAIGHT EDGE TILE TRIM HOMELUX®

**COPPER**



**CHAMPAGNE**



**BLACK GLOSS**



**WHITE GLOSS**



PRODUCT CODE	DESCRIPTION	COLOUR	LENGTH
<b>12.5mm</b>			
HPJT125 SI 25	Metal Straight Edge Tile Trim	Silver	2.5m
HPJT125 SSE 25	Metal Straight Edge Tile Trim	Stainless Steel	2.5m
HPJT125 BK 25	Metal Straight Edge Tile Trim	Black Gloss	2.5m
HPJT125 WHGL 25	Metal Straight Edge Tile Trim	White Gloss	2.5m
HPJT125BB25	Metal Straight Edge Tile Trim	Brushed Black	2.5m
HPJT125CARB25	Metal Straight Edge Tile Trim	Carbon	2.5m
HPJT125COP25	Metal Straight Edge Tile Trim	Copper	2.5m
HPJT125CHAM25	Metal Straight Edge Tile Trim	Champagne	2.5m
HPJT125GMG25	Metal Straight Edge Tile Trim	Gun Metal Grey	2.5m
HPJT125PEW25	Metal Straight Edge Tile Trim	Pewter	2.5m

## PROFILES

**6mm**

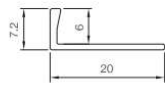

**8mm**

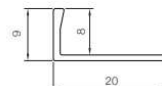

**10mm**

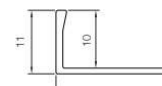

**12.5mm**

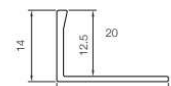



# STAINLESS STEEL STRAIGHT EDGE OUTDOOR TILE TRIM HOMELUX®

STAINLESS STEEL  
OUTDOOR



PRODUCT CODE	DESCRIPTION	COLOUR	LENGTH
22mm			
HPJT22SS25	Stainless Steel Straight Edge Tile Trim	Stainless Steel	2.5m





**POLISHED SILVER**



## STAINLESS STEEL STRAIGHT EDGE TILE TRIM **HOMELUX®**

PRODUCT CODE	DESCRIPTION	COLOUR	LENGTH
<b>10mm</b>			
HPJT10POL25	Stainless Steel Straight Edge Tile Trim	Polished Silver	2.5m
<b>12.5mm</b>			
HPJT125POL25	Stainless Steel Straight Edge Tile Trim	Polished Silver	2.5m

### PROFILES

**10mm**

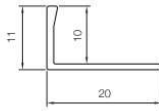

**12.5mm**

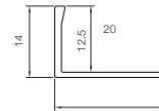

**SILVER TRADE**



## METAL STRAIGHT EDGE TILE TRIM TRADE

PRODUCT CODE	DESCRIPTION	COLOUR	LENGTH
<b>6mm</b>			
HPJT8TR SI	Metal Straight Edge Tile Trim	Silver	2.44m
<b>10mm</b>			
HPJT10TR SI	Metal Straight Edge Tile Trim	Silver	2.44m
<b>12.5mm</b>			
HPJT125TR SI	Metal Straight Edge Tile Trim	Silver	2.44m

SILVER



STAINLESS STEEL



## METAL SQUARE EDGE TILE TRIM HOMELUX®

PRODUCT CODE	DESCRIPTION	COLOUR	LENGTH
<b>9mm</b>			
HAT SQD SI 6	Square Edge Metal Tile Trim	Silver	1.83m
HAT SQD SI 25	Square Edge Metal Tile Trim	Silver	2.5m
HAT SQD SSE 25	Square Edge Metal Tile Trim	Stainless Steel	2.5m
<b>12mm</b>			
HAT SQ125 SI 25	Square Edge Metal Tile Trim	Silver	2.5m
HAT SQ125 SSE 25	Square Edge Metal Tile Trim	Stainless Steel	2.5m



### PROFILES

9mm

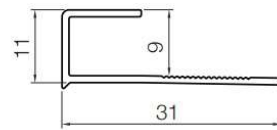

12mm

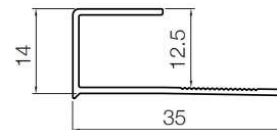

SILVER



STAINLESS STEEL



## METAL SQUARE EDGE CORNERS

PRODUCT CODE	DESCRIPTION	COLOUR
<b>9mm</b>		
HATCSQDSIPK2	Square Edge Metal Tile Trim Corners	Silver
HATCSQDSSEPK2	Square Edge Metal Tile Trim Corners	Stainless Steel
<b>12mm</b>		
HACSQ125SIPK2	Square Edge Metal Tile Trim Corners	Silver
HACSQ125SSEPK2	Square Edge Metal Tile Trim Corners	Stainless Steel



# METAL QUADRANT TILE TRIM TRADE

SILVER



PRODUCT CODE	DESCRIPTION	COLOUR	LENGTH
<b>8mm</b>			
HAQDT8 SI	Metal Quadrant Tile Trim	Silver	2.44m
<b>10mm</b>			
HAQDT10 SI	Metal Quadrant Tile Trim	Silver	2.44m
<b>12mm</b>			
HAQDT12 SI	Metal Quadrant Tile Trim	Silver	2.44m



# METAL QUADRANT CORNERS

SILVER



PRODUCT CODE	DESCRIPTION	COLOUR
<b>8mm</b>		
HAQDC8 SI	Metal Quadrant Tile Trim Corner	Silver
<b>10mm</b>		
HAQDC10 SI	Metal Quadrant Tile Trim Corner	Silver
<b>12mm</b>		
HAQDC12 SI	Metal Quadrant Tile Trim Corner	Silver

## PROFILES

8mm

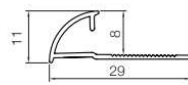

10mm

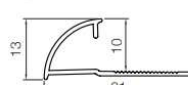

12mm

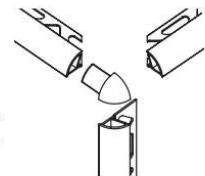
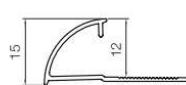

METAL  
TILE TRIMS



**HOMELUX<sup>®</sup>**

**TRIANGLE &  
AFTER-FIT  
TRIM**

NEW ANGULAR DESIGNED TRIM TO  
GIVE THAT FINISHED LOOK

# METAL TRIANGLE TILE TRIM HOMELUX®



SILVER

PRODUCT CODE	DESCRIPTION	COLOUR	LENGTH
<b>10mm</b>			
HTR10SI25	Metal Triangle Tile Trim	Silver	2.5m
<b>12.5mm</b>			
HTR125SI25	Metal Triangle Tile Trim	Silver	2.5m



## PROFILES

10mm

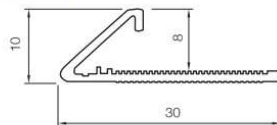

12.5mm

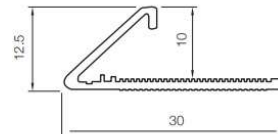

# METAL AFTER FIT TILE TRIM



SILVER

PRODUCT CODE	DESCRIPTION	COLOUR	LENGTH
<b>8mm</b>			
HAFT8SI6	Metal After-Fit Tile Trim	Silver	1.83m
<b>10mm</b>			
HAFT10SI6	Metal After-Fit Tile Trim	Silver	1.83m

This trim is ideal to cover bare edge tiles in any area such as:

- Bathroom Splashback
- Kitchen Splashback
- Cloak Rooms

### Quick & Easy to Install

1. Cut and/or mitre

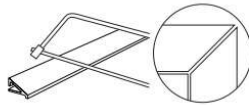

2. Prepare trim and apply adhesive

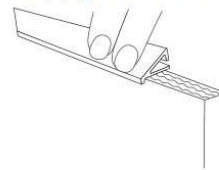

3. Finish and clean

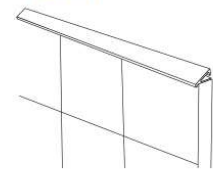

### PROFILES

8mm

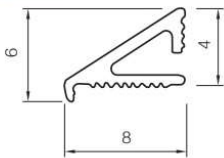

10mm

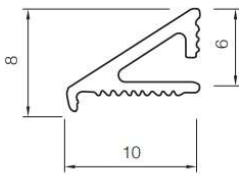

1. Bare edge on pre-installed tile



2. Apply adhesive and After Fit Trim



3. Finish and clean



LISTELLO  
BORDERS

**HOMELUX<sup>®</sup>**

**LISTELLO  
BORDERS**

ADD A TOUCH OF LUXURY TO TILED AREAS.  
USE HORIZONTALLY OR VERTICALLY  
BETWEEN TILES OR AS A FINISHED EDGE

Match Listello Borders to taps, door handles and mirrors to create  
a harmonised feel to your bathroom or kitchen



## METAL TILE STRIP LISTELLO BORDERS



PRODUCT CODE	DESCRIPTION	COLOUR	LENGTH
<b>10mm Wide</b>			
HTSN GO 6	Narrow Tile Strip	Gold	1.83m
HTSN SI 6	Narrow Tile Strip	Silver	1.83m
HTSN SSE 6	Narrow Tile Strip	Stainless Steel	1.83m
HTSN SI 8TR	Narrow Tile Strip	Silver	2.44m
HTSN SSE 8TR	Narrow Tile Strip	Stainless Steel	2.44m
<b>20mm Wide</b>			
HTSW SI 6	Wide Tile Strip	Silver	1.83m
HTSW SI 8TR	Wide Tile Strip	Silver	2.44m

### PROFILES

#### 10mm

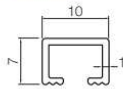

#### 20mm

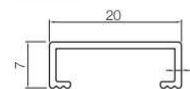

#### 20mm

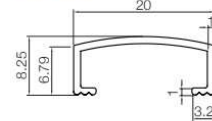

## METAL LUXURY TRIM LISTELLO BORDERS

PRODUCT CODE	DESCRIPTION	COLOUR	LENGTH
<b>32mm Wide</b>			
HLTD SSE 6	Luxury Metal Border	Stainless Steel	1.83m

### PROFILE

#### 32mm

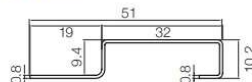

# BATH & SHOWER SEALS

**HOMELUX<sup>®</sup>**

## BATH & SHOWER SEALS

HOMELUX<sup>®</sup> SEALS PROVIDE FUNCTIONAL,  
NEAT SOLUTIONS TO SEAL SHOWERS  
AND BATHS



During and after tiling products • Hide mouldy or unsightly silicone  
Cover gaps between the bath/shower tray and tiles • Prevent damage to your property  
Helps to prevent unsightly damp patches on adjacent walls and ceilings

# BEFORE-FIT BATH & SHOWER SEALS

## PROFILE

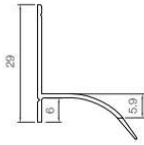

## PRO-SEALASTRIP SEAL

PRODUCT CODE	DESCRIPTION	COLOUR	LENGTH
HPBS100	Pro SealaStrip	White	1.83m

Pro SealaStrip is an effective, long-lasting PVC seal that can be fixed around baths and shower trays during tiling



## BATH AND SHOWER SEAL

PRODUCT CODE	DESCRIPTION	COLOUR	LENGTH
HFLEXSBS35	Bath and Shower Seal	Grey	3.5m

Bath and Shower Seal is a flexible, easy to fit seal which can be fixed around the bath or shower tray before it is installed, creating a 100% waterproof seal when used in conjunction with Homelux Waterproof Matting

# AFTER-FIT BATH & SHOWER SEALS

## PROFILE

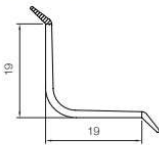

## BATH SEAL

PRODUCT CODE	DESCRIPTION	COLOUR	LENGTH
H9301001	Bath Seal	White	1.75m

Bath Seal is easy to fit and prevents water and condensation from dripping behind the bath, shower tray or vanity unit

## PROFILE

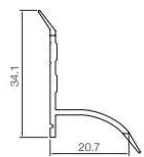

## SEALASTRIP SEAL

PRODUCT CODE	DESCRIPTION	COLOUR	LENGTH
HBS701	SealaStrip	White	1.83m

SealaStrip is a rigid PVC seal for use around bath and shower trays

## PROFILE

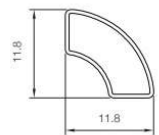

## BATH TRIM SEAL

PRODUCT CODE	DESCRIPTION	COLOUR	LENGTH
HBTM100	Bath Trim	White	1.83m

Bath Trim hides the join between tiled surfaces around baths and showers. It has a unique glazed ceramic effect to complement high gloss tiles and is easily applied with its self-adhesive tape

## PROFILE

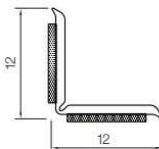

## FLEXIBLE BATH SEAL

PRODUCT CODE	DESCRIPTION	COLOUR	LENGTH
HFBS WH	Flexible Bath Seal	White	3.5m

Flexible Bath Seal is a self-adhesive seal to hide the join around baths and shower trays

WATERPROOF  
MATTING



**HOMELUX<sup>®</sup>**

**WATERPROOF  
& ANTI-CRACK  
MATTING**

WATERPROOF MATTING GIVES A 100%  
GUARANTEED SEAL, PROTECTING YOUR  
PROPERTY AGAINST INTRUSIVE WATER  
AND MOISTURE

Waterproofing and sealing against water and moisture is the most important element of any tiled wetroom or shower installation

# WHY DO I NEED WATERPROOF MATTING?

## WHAT ARE THE BENEFITS OF WATERPROOF MATTING?

- ✓ Ensures complete watertight protection, preventing the migration of vapour from the tile surface to the substrate
- ✓ Prevents costly damage to timber frames, building joints and plaster boards caused by leaks
- ✓ Prevents unsightly damp patches on the ceiling in the room below

Homelux Waterproof Matting can be used under any tile application.

- Quick and easy to apply
- Can be tiled on to instantly
- 10 year guarantee\*
- Floor matting incorporates anti-crack properties for tiles
- Uniform thickness of 0.85mm with no weak points
- Joint tape, corners and pipe collars available to ensure a complete seal
- Compatible with Homelux® electric underfloor heating

\*When fitted in accordance with Homelux® instructions using Homelux accessories

## WATERPROOF MATTING

### EXTERNAL CORNERS



### INTERNAL CORNERS



### JOINT TAPE

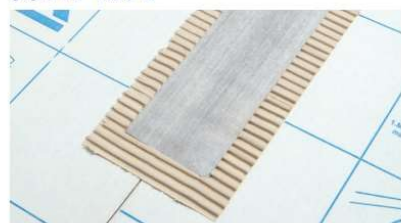

### PIPE COLLARS



PRODUCT CODE	DESCRIPTION	LENGTH
HPXF5UK	Waterproof Anti Crack Floor Matting	5m x 1m
HPXW5UK	Waterproof Wall Matting	5m x 1m

### FLOOR MATTING



### WALL MATTING



## STANDARD WATERPROOF ACCESSORIES

PRODUCT CODE	DESCRIPTION	LENGTH/PACK
HPXPC2UK	Waterproof Matting Pipe Collars	Pack of 2
HPXEC2UK	Waterproof Matting External Corners	Pack of 2
HPXJT10UK	Waterproof Matting Joint Tape	10m

## FLEXIBLE WATERPROOF ACCESSORIES

PRODUCT CODE	DESCRIPTION	LENGTH/PACK
HPXFC2UK	Pipe Flexible Collar	Pack of 2
HFLEXWPMEC	Flexible External Corner	Pack of 1
HFLEXWPMIC	Flexible Internal Corner	Pack of 1
HFLEXWPMPC	Flexible Pipe Collar	Pack of 1
HFLEXWPMJT	Flexible Joint Tape	5m

ANTI-CRACK  
MATTING

**HOMELUX<sup>®</sup>**

# ANTI-CRACK MATTING

NEWLY DEVELOPED DECOUPLING  
MAT WITH ADVANCED  
LAMINATION TECHNOLOGY

The new problem solver for stress relief and waterproofing in professional interior construction.

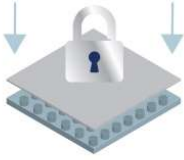

## Mechanical Bonding

Bonding layers have reinforced fleece which locks into the mat, ensuring strong reliable installations.

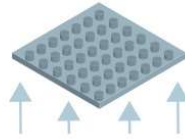

## Vapour Permeable

Protects tile installation by blocking excess moisture vapour.

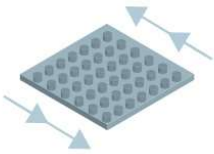

## Decoupling Membrane

Absorbs stress and preserves the surface and integrity of the tile and grout.



## Waterproofing

Protects moisture sensitive substrates. For interior and exterior use.

- ✓ Ideal for use with underfloor heating. With its unique insulating layer, water and electric underfloor heating efficiency is improved
- ✓ Absorbs substrate movement to prevent surface cracks & the de-lamination of Tile & Stone
- ✓ Double fleece & glue free bonding ensures a secure and durable anchor of the floor finish over the base substrate
- ✓ Hydrophile fleece transport moisture and lets adhesive cure fast
- ✓ Rolls out flat making it easy to lay
- ✓ Replaces 6mm backer board or a second layer of plywood under flooring installations
- ✓ Completely waterproofs underneath tiled areas when used with Homelux® joint tape
- ✓ Use with a powder based C2 flexible thin-set tile adhesive

### ULTRA MAT MATTING



## Anti-crack Matting

PRODUCT CODE	DESCRIPTION	LENGTH
HULMAT5	Ultra Mat Matting	5m

### JOINT TAPE



## Joint Tape DECOUPLING AND WATERPROOF MATTING

PRODUCT CODE	DESCRIPTION	LENGTH
HULTTAP5	Joint Tape	5m

Note: When laying on to wooden floors, ensure it is structurally sound and level. Check with the adhesive manufacturer's instructions regarding any priming that may be necessary.

UNDER TILE  
HEATING

**HOMELUX<sup>®</sup>**

# UNDERTILE HEATING

CREATE AN EVEN SPREAD OF WARMTH  
THROUGHOUT TILED AREAS

One of the most cost effective heating methods, also compatible with Homelux Waterproof Matting to create a luxurious wet room which is warm underfoot



# WHAT ARE THE BENEFITS OF UNDERTILE HEATING?

- Creates an even spread of comfortable warmth with no hot spots or draughts
- Cost-effective form of heating, maintenance free
- Creates space - no bulky radiators
- Helps to dry wetrooms quicker

## WHY HEATWAVE UNDER TILE HEATING?

- ✓ Suitable for use under any porcelain, ceramic or natural stone tiles
- ✓ Fully adaptable, suitable for any room shape
- ✓ Quick and easy to install
- ✓ Choice of thermostats for optimum efficiency and convenience
- ✓ Up to 50% more thermally efficient when used with Heatwave Insulation Boards
- ✓ Multiple mats can be joined together
- ✓ Only one power lead to wire in to thermostat
- ✓ 10 year guarantee for heat mats\*
- ✓ 2 year guarantee for thermostats\*

### UNDERTILE HEAT MAT

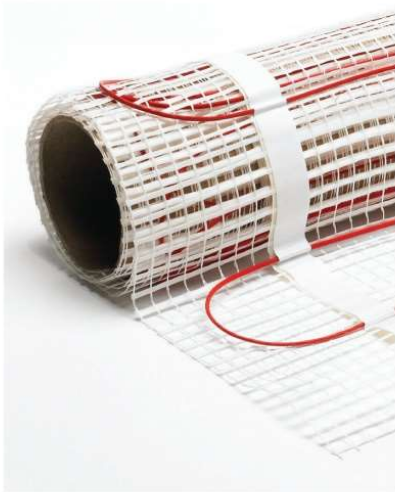

### HEATING MATS UNDERTILE HEATING

PRODUCT CODE	DESCRIPTION	SIZE
HHW M2	Heatwave Undertile Heat Mat	2sqm
HHW M3	Heatwave Undertile Heat Mat	3sqm
HHW M4	Heatwave Undertile Heat Mat	4sqm
HHW M5	Heatwave Undertile Heat Mat	5sqm

### ACCESSORIES UNDERTILE HEATING

PRODUCT CODE	DESCRIPTION	LENGTH	DEPTH
HHW GFT	Heatwave Glass Fibre Tape 10m	10m	-
HHW IB	Heatwave Insulation Board	1.2m	0.6mm
HHW STSC	Heatwave Manual Thermostat	N/A	-
HHW LTSC	Heatwave LCD Thermostat	N/A	-



**GLASS FIBRE TAPE**



**INSULATION BOARD**



**MANUAL THERMOSTAT**



**LCD THERMOSTAT**



\*When fitted in accordance with Homelux® instructions using Homelux accessories by a qualified electrician

# KITCHEN TRIM & SEALS

**HOMELUX<sup>®</sup>**

## KITCHEN TRIMS & SEALS

BEFORE AND AFTER FIT SOLUTIONS  
FOR KITCHEN FLOORS AND WORKTOPS



**Before-Fit Trims and Seals cover gaps between worktops and walls, creating a flawless finish and preventing the migration of water behind worktops**

**After-Fit Trims and Seals are ideal to renovate an existing installation and cover any gaps caused by natural movement and wear, providing a stylish finish**

## PVC WORKTOP KITCHEN TRIMS



WHITE

PRODUCT CODE	DESCRIPTION	COLOUR	LENGTH
<b>6mm - Before-Fit</b>			
HICCWH625	Internal Corner Cove	White	2.5m
<b>9mm - Before-Fit</b>			
HICC100	Internal Corner Cove	White	2.5m

PVC Internal Corner Cove creates a neat joint between tiled walls when tiling into a vertical corner. It can also be used horizontally as a transition between vertical walls and worktop surfaces in bathrooms.

### PROFILES

6mm

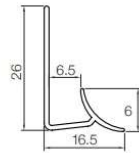

9mm

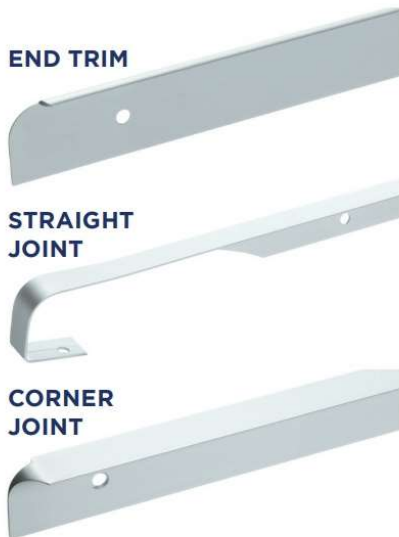
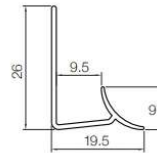

END TRIM

STRAIGHT JOINT

CORNER JOINT

## METAL WORKTOP JOINT TRIMS

PRODUCT CODE	DESCRIPTION	DEPTH	LENGTH
<b>30mm</b>			
H9535001	Satin Worktop End Trim	30mm	0.63m
H9525001	Satin Worktop Straight Joint Trim	30mm	0.63m
H9505001	Satin Worktop Corner Joint Trim	30mm	0.63m
<b>40mm</b>			
H9545005	Satin Worktop End Trim	40mm	0.63m
H9545003	Satin Worktop Straight Joint Trim	40mm	0.63m

## PLINTH SEAL



CLEAR

PRODUCT CODE	DESCRIPTION	COLOUR	LENGTH
<b>18mm</b>			
HPS201	Plinth Seal	Clear	1.83m

Plinth Seals provide a hygienic seal between the floor and kitchen unit plinth whilst hiding and protecting the raw edges of the plinth from water exposure, therefore helping to prevent any potential water damage and chipboard warping.

### PROFILES

16mm

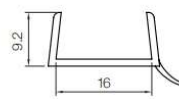

18mm

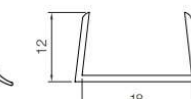

FLOORING  
PRODUCTS

**HOMELUX<sup>®</sup>**

**FLOORING  
PRODUCTS**

COVER THE JOIN BETWEEN TWO FLOOR  
COVERINGS WITH A PROFESSIONAL  
FLOORING TRIM

A variety of floor profiles, including solutions to accommodate differing floor heights

# METAL GRIPSTRIP

Gripstrips cover the join between carpet and other floor coverings.

**SILVER**



**GOLD**



PRODUCT CODE	DESCRIPTION	COLOUR	LENGTH
HCTT SI 3	Gripstrip	0.91m	Silver
HCTT GO 3	Gripstrip	0.91m	Gold
HCTT SI 8	Gripstrip	2.44m	Silver

## PROFILE

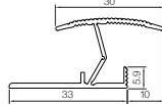

BUILDING  
PRODUCTS

**HOMELUX<sup>®</sup>**

# BUILDING PRODUCTS

PVC SOLUTIONS TO REINFORCE CORNER  
JOINTS AND CREATE END STOPS



Suitable for internal or external use in all plastering applications

**CORNER BEAD ARCH BEAD**

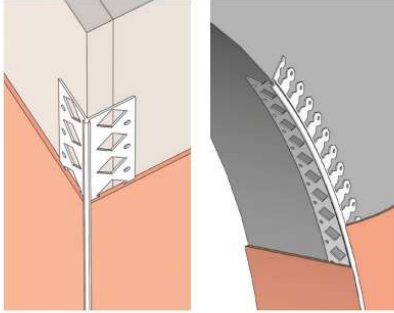

**EDGE BEAD CORNER BEAD**

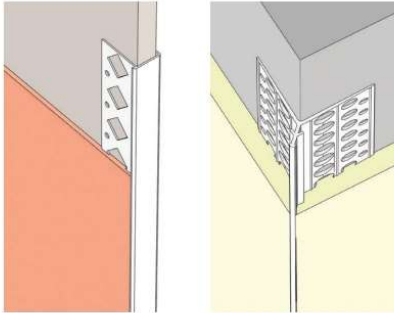

**WHITE ANGLE**

**BLACK ANGLE**

**WHITE CLIP ON**

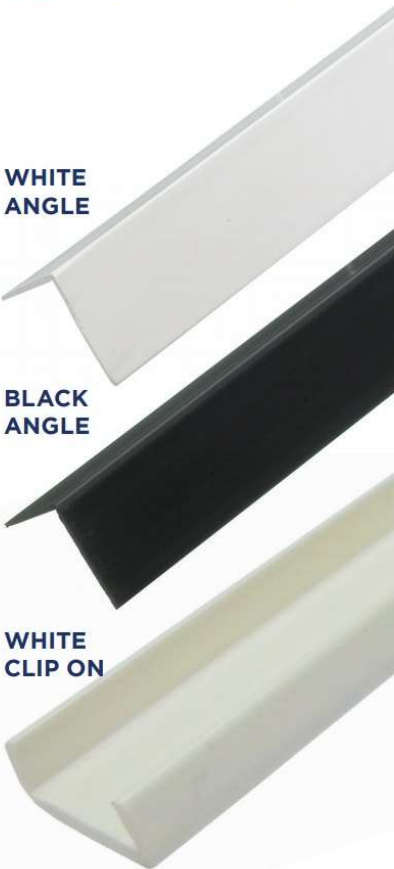

**PLASTER BEADS ANGLES & EDGES**

PRODUCT CODE	DESCRIPTION	COLOUR	LENGTH
<b>25mm</b>			
HNR1456	Corner Bead	White	2.5m
HNR1660	Arch Bead	White	2.5m
<b>10mm</b>			
HNR1468	Edge Bead	White	2.5m

**RENDER BEADS ANGLES & EDGES**

PRODUCT CODE	DESCRIPTION	COLOUR	LENGTH
<b>15mm</b>			
MCB15W	Corner Bead	White	3m

**PROTECTIVE ANGLES**

PRODUCT CODE	DESCRIPTION	COLOUR	LENGTH
<b>13mm</b>			
HAR037	External Angles	White	2.43m
HAR035	External Angles	Black	2.43m
<b>19mm</b>			
HAR049	External Angles	White	2.43m
HAR047	External Angles	Black	2.43m
<b>25mm</b>			
HAR055	External Angles	White	2.43m
HAR053	External Angles	Black	2.43m
<b>32mm</b>			
HAR061	External Angles	White	2.43m
<b>51mm</b>			
HAR067	External Angles	White	2.43m

**INTERNAL ANGLE**

PRODUCT CODE	DESCRIPTION	COLOUR	LENGTH
<b>19mm</b>			
HHE421	Interior Angle	White	2.43m

**CLIP ON EDGES**

PRODUCT CODE	DESCRIPTION	COLOUR	LENGTH
<b>16mm</b>			
HHE601	Clip on Edge	White	2.43m
HHE607	Clip on Edge	Black	2.43m

**LIPPED EDGES**

PRODUCT CODE	DESCRIPTION	COLOUR	LENGTH
<b>16mm</b>			
HHE701	Lipped Edge	White	2.43m
HHE703	Lipped Edge	Cream	2.43m

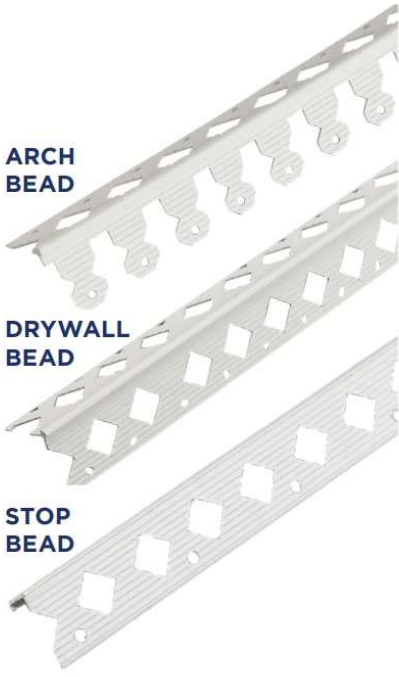

## PVC INDOOR BEADS

PRODUCT CODE	DESCRIPTION	SIZE	LENGTH
HN90007958	Arch Plaster Bead	2-3mm	2.5m
HN90007538	Drywall Internal Bead	2mm	2.5m
HN90007537	Stop Internal Internal Bead	12mm	3m



## PVC OUTDOOR BEADS

PRODUCT CODE	DESCRIPTION	SIZE	LENGTH
HN90007964	Corner Render Bead	10-12mm	2.5m
HN90007965	Corner Render Bead	18-20mm	2.5m
HN90007977	Movement Render Bead	10-12mm	2.5m
HN90007961	Stop Render Bead	10-12mm	2.5m
HN90007960	Stop Render Bead	18-20mm	2.5m
HN90007540	Bellcast Render Bead	20mm	3m





# MARKETING SOLUTIONS

## 2ft TRIM STAND

PRODUCT CODE	DESCRIPTION
HMKIT222GY	2 ft Trim Stand



## 1ft TRIM STAND

PRODUCT CODE	DESCRIPTION
HMKIT221GY	1 ft Trim Stand





Our unique Bus Stop POS solution features each size profile for the convenience of the customer so they can check they are buying the correct size trim.



### 4ft TRIM STAND

PRODUCT CODE	DESCRIPTION
HMKIT401GY	4 ft Trim Stand

### BOUTIQUE STAND

PRODUCT CODE	DESCRIPTION
HMBOUTIQUE2FT	2 ft Boutique Trim Stand



- Keyrings
- Inspirational Content



## ULTRA MAT FSDU



Our FSDUs (Free Standing Display Units) are great for small spaces and aisle ends to complement products that can be used in conjunction with each other.

A great way to have products in multiple places within the store.

Follow us on



**HOMELUX<sup>®</sup>**

**TILE TRIMS**

**LISTELLO BORDERS**

**BATH & SHOWER SEALS**

**WATERPROOF MATTING**

**ANTI-CRACK MATTING**

**UNDER TILE HEATING**

**PLASTER BEADING**

**Homelux UK Ltd  
The Maltsters,  
Wetmore Road  
Burton upon Trent  
Staffordshire DE14 1LS**

**Tel: 01283 245 430  
Email: [sales@qep.com](mailto:sales@qep.com)  
Web: [www.homelux.co.uk](http://www.homelux.co.uk)**

A division of  
**QEP**